

# PA91H - 4G Intelligence HD Manual

## Dispatched Ball User Manual



# Menu

- 1 Version .....
- 2 Description.....
- 3 Introduction.....
  - 3.1 **Overview** .....
  - 3.2 **Main function**.....
  - 3.3 **Application solution** .....
- 4 Specification .....
- 4.1 **Inner structure**.....
  - 4.1.1 **Summary**.....
- 4.2 **Definition of front panel** .....
- 4.3 **Definition of back panel** .....
- 4.3.1 **Power line** .....
- 4.3.2 **19V adaptor**.....
- 4.4 **Detailed specification** .....

- 5 Set up .....
- 5.1 **Set up guide** .....
- 5.1.1 **Set up environment**.....
- 5.1.2 **Open box and accesories checking**.....
- 5.1.3 **Set up guide**.....

- 6 Operation guide.....
  - 6.1 **Remote controller function keys** .....

# Important security rules and prompt

## ! Warning:

Please do read below warnings before setting up and using this product:

1. Take and put lightly during transportation.
2. All installing and maintenance should be executed by professional person.
3. Should not be put on where rained or other corrosive liquid pureed for long time.
4. Installing way and materials used should be able to withstand the weight of the machine.
5. Keep far from heat source, strong magnetic field and dust.
6. Do not put heavy things on top of the equipment, no stacking debris around inside 50cm.
7. Do not flush water directly to the equipment while cleaning the vehicle.
8. Output power of the equipment not allow to connect to other not recommended equipment.
9. Do not try to put your fingers or anything into the cracks of the equipment while is working.
10. Do not open or disassemble the equipment without professional guide.
11. Do not change any modules while equipment is charged.

## 1 Version

M91H-4G Intelligence HD Dispatched Ball

## 2 Description

This manual introduced a integrated IR CCTV equipment, which integrated 1 channel 1080P AHD recording, 3G/4G, WIFI and GPS/BD, high speed ball type machine. Module number is M91H(Below call it M91H in short). This manual describes it's features, detailed specifications, function and attention of each modules, signal definition of connectors, interface and operations.

Including below chapters:

**Error! Reference source not found.**Product introduction: Believe introduced product function, main features and typical applications.

4 Equipment specifications : Detailed describe summary, feature, specification and attentions for each function modules, including recording module and other function modules, also describe the appearance of M91H.

5 Equipment set up: Introduce the equipment set up and accessories.

**Error! Reference source not found.**Equipment operation guide: Introduced remote controller usage, each displayed menu function and usage.

## 3 Product introduction

### 3.1 Product description

M91H is a high performance integrated equipment designed for video monitor and remote monitor. It uses high speed processor and embedded operating system, combined the most advanced H.265 video compression/decompression technology. M91H support 1 channel 1080P (Analog HD) recording and wireless data upload, work with CMS (Central Management Software) can execute central monitor, remote management and play back analyst bass on

central database. M91H product appearance is simple and generous, set up and move is flexible and convenient, huge functions and high reliable.

Features:

- Industry grade design, appropriate interface, make sure working reliably and stably under complex environment;
- Newest audio compression technology;
- Support 1 ch audio/video storage;
- Professional and stable file system;
- Expendable 3G, 4G, WIFI, GBS/BD function modules;
- Support local and remote cradle control;
- Support 2 SD cards, each card up to 256G;
- Build-in UPS power, endurance time reach 10Hr-15Hr;
- Support quick boot;
- Support iOS, Android portal device monitoring software;

### 3.2 Product main function

Table 1 M91H main function list

System	Function	Description
<b>Recording Sub-system</b>	Record Channel	1 Channel
	Resolution	Support 1 Ch 1080P recording
	Image quality	Default 4M bps
	OSD	Overlays letters, like date / time, channel ID, GPS/BD, etc into the video
	Loop record	Support SD card loop recording and loop deleting
	Record model	Support turn on recording, manual recording, alarm recording and timing recording

	Disk cover	Support disk auto cover
<b>Play back Sub-system</b>	Recording	Appropiative software, can live view video on PC which is in the same LAN;
	search	Appropiative software,can download video on PC which is in the same LAN;
<b>Configuration</b>	Turn on/off	Support button delayed turn off;

### 3.3 Product application solution

PA91H apply to local enforcement video and remote monitor. It's common application process is as following:

Device installed on law enforcement car or fix on tripod in the law enforcement scene:

- Device online and report to CMS by 4G;
- Device transports the live video to command center by 4G, command center execute remote command base on the live video;
- At the same time, device storage the video into SD cards, which can be evidence;

M91H application diagrammatic sketch (As below)



## 4 Device specification

This chapter introduce the functions, features, detailed specification and attentions.

### 4.1 Device inner structure

#### 4.1.1 Overview

M91H integrated with a set of video decode chip, fulfil functions such as decode, video storage, etc.

Structure as below:

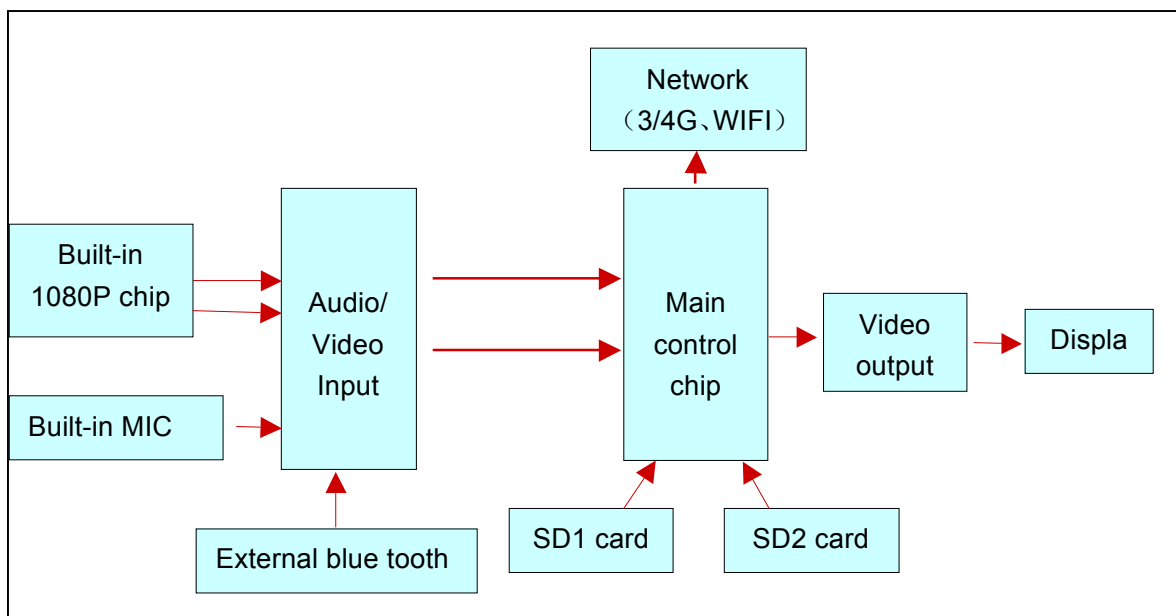

Monitor system block diagram

Work flow as below:

- Record video, record audio:
  - Input video through built-in camera, then compress, storage preview and output by main chip;
  - 1. Locale playback
    - Appropiative software, can live view video on PC which is in the same LAN;
    - Appropiative software,can download video on PC which is in the same LAN;
  - 2. Remote playback
    - Remote playback by connecting client with server;

## 4.2 Front panel definition

Front panel as below:



- 1: OLED high light display panel, visible outdoors under sunshine;
- 2: Display device main function status;

## 4.3 Back panel definition



- 1: Support dual SD cards, SD card gap towards inside, SD card chip down;
- 2: SIM card gap towards inside, chip down;



- 3: MODE key, short press 1sec to switch network, that is: 4G, WIFI, WIFI+4G, WIFI AP+4G
- 4: BT key: Press shorter than 1sec to turn on/off blue tooth, longer than 1.5sec to remove the blue tooth connection records;

**4.3.1 Power line**

Below image is the power line, one end is 9 pins aerial plug which plug on the DC male connector on the back panel; Another end, PWD connect to 19V adaptor, BNC head is CVBS video output, yellow line is audio output, orange line is audio input;



**4.3.2 19V adaptor**



19V adaptor

## 4.4 Detailed specifications

Table 2 M91H detailed specification

Item	Description	
Operating system	Linux	
Industry design	Safety, reliable, military grade water proofing interface design	
Image operating interface	Configure by external display screen and remote controller	
Language	Simple Chinese, Traditional Chinese, English, other(Optional)	
Security	User password, Administrator password management	
Video & Live	Input / output	Built in 1ch 1080P video input, 1 ch video output; 1.0Vp-p, 75 Ω
	OSD	Overlays letters, like date / time, etc into the video
	Compression	H.265, Use Hisilicon 3516D high performance processor;
	Dual stream	Support
	Preview	Support single channel preview
	frame rate	1080P:PAL: 25fps; NTSC: 30fps
	Resolution	Support 1080P, 720P, decode format
	Image quality	Default 4M bps
Audio	Video rate	720P: 1024kbps / 2048kbps / 3072kbps / 4096kbps / 5120kbps, 5 grades adjustable 1080P: 2048 kbps / 3072 kbps / 4096 kbps / 5120 kbps / 6144 kbps, 5 grades adjustable
	Audio input / output	Bluetooth input / Bluetooth output
Record	Compression	G.726
	Storage	Support 2pcs SD card, each card up to 256G; Support SD card loop recording and loop deleting
	Record strategy	Default turn on record, support timing record, etc.
	Record search	Can search by record time, record type, storage device, etc;
Alarm	Record playback	1: Appropiative software, can live view video on PC which is in the same LAN; 2: Appropiative software,can download video on PC which is in the same LAN; The client end support fast forward, fast back, play, suspend control, support 2, 4, 8, 16 times speed fast forward or back, support timing replay control.
	Alarm input	1 Ch IO/ alarm input and 1 Ch alarm output(Optional)
	Alarm record	Pre-record function, pre-record 15sec before alarm, record after alarm can set as 10sec~1800sec;
	Storage space alarm	Support disk space alarm function;
	Function alarm	Video lost alarm;
Localization	GPS	GPS signal lost alarm
Localization		Built-in GPS,BD

G-Sensor		Built-in G-Senor
Mobile network (Optional)		Support 3G, 4G, WIFI
System upgrade		SD card upgrade, client end upgrade;
Power and consumption	Power management	Button turn on/off With overload protection, undervoltage protection, short circuit protection, reverse protection, etc;
	Input voltage	DC:+19V
	Consumption	Working in day time<8.74W; Working at night< 15.2W
Working environment	Temperature	-20℃ ~ +55℃
	Humidity	10% to 95%
Size		170(W) x 277 (H) x 170(D) mm
Weight		<b>5KG</b>

## 5 Device set up

### 5.1 Device set up guide

#### 5.1.1 Set up environment

M91H adapt to complex urgent environment, detailed index as below table:

Table 4 M91H Environment performance index table

Item	Index	Comments
Working max temp	+60°C	Airy condition;
Working min temp	-25°C	
Relative humidity	10%~95%	
Max temp gradient	20°C/Hr	
Vibration limited (Not charged)	≤5mm p-p (5 – 22Hz) 49m/s <sup>2</sup> (5.0G) (22 – 500Hz)	With packing, transportation, movement
Vibration limited (Working)	≤1.0mm p-p (5 - 22Hz) 9.8 m/s <sup>2</sup> (1.0G)(22 – 500Hz)	Device set up firmly well. The vibration of the vehicle is normally under 0.5Grms.
Attack limited (Not charged)	≤2000G(19, 600m/s <sup>2</sup> ) (Duration 1 ms, half-sine wave)	With packing, without hard disk, transportation, movement drop, just as drop on the cement floor from 1.5 meter high;
Attack limited (Working)	≤1000G, (9, 800m/s <sup>2</sup> ) (Duration 1 ms, half-sine wave)	Set up well;

#### 5.1.2 Open box and accessories checking

**Please check the device right after open box, to see if it's out of shape or other kind of damage, if so please stop using it and contact with your supplier.**

### 5.1.3 Device set up guide

#### 5.1.3.1 Device set up

Two ways to set up (Optional):

- 1、 I-shaped bracket: Usually set up on top of police car, please refer to below image;
- 2、 Tripod: Usually set up for monitoring on fixed point;





## 6 Device operation guide

### 6.1 Remote controller function keys description

**Digital keys:** To input digit on system configuration interface;

**Direction keys:** To move from selection, data area and image;

Press **【ENTER】** key select, press **【RETURN】** key return.

Remote controller buttons and function introduction:

a) Digital key area :

**0 - 9】** : On configuration status, digital keys used for select digit.

On live view/play back status, 1、 2、 3、 4 keys used for switch from channels, press 0 key, return to 4 channels interface.

**【 + 】** 、 **【 - 】** : Used for adjust analog quantity;

b) Configure menu navigation:







**▲**、 **▼** : **Up**、 **Down** cursor movement direction keys;

**◀**、 **▶** : **Left**、 **Right** cursor movement direction keys;

**【ENTER】** : Under configuration status, it stands for choose and save; Under play back status, press enter key, will display those parameters with 'ON' from “display configuration ”menu on screen;

c) Other function keys:

Table 5 Description for remote controller other function keys

Key	Function	Image
<b>【0—9】</b>	<b>【0—9】</b> key: On configuration status, digital keys used for select digit.  On live view/play back status, 1、 2、 3、 4 keys used for switch from channels, press 0 key, return to 4 channels interface.	
	Return to preview page or back to upper menu;	
	Confirm key of select, config, play, etc for System configuration parameters; Press this key while play back will overlays letters, like date /time, vehicle ID, GPS, etc into the video	
<b>▲</b> , <b>▼</b> , <b>◀</b> , <b>▶</b>	Direction keys; Up, Down, Left, Right cursor direction movement keys;  While video play back, Right direction key is for fast forward; Left direction key is for fast backward;  While preview, Left and Right direction keys displays status information of device system;	
	To execute 4 channel image capture function;	
	Delete key, delete the inputs selected;	
	To tab from one input area to next area;	
Others	Reserved function keys;	

## 6.2: Mobile phone APP configuration

When need to configure M91H by mobile phone, need to switch the network to WIFI AP model, which is as described in chapter 4.3 for back panel description.

- 1: Installation and configure software(As image below), if have no software please contact your supplier.

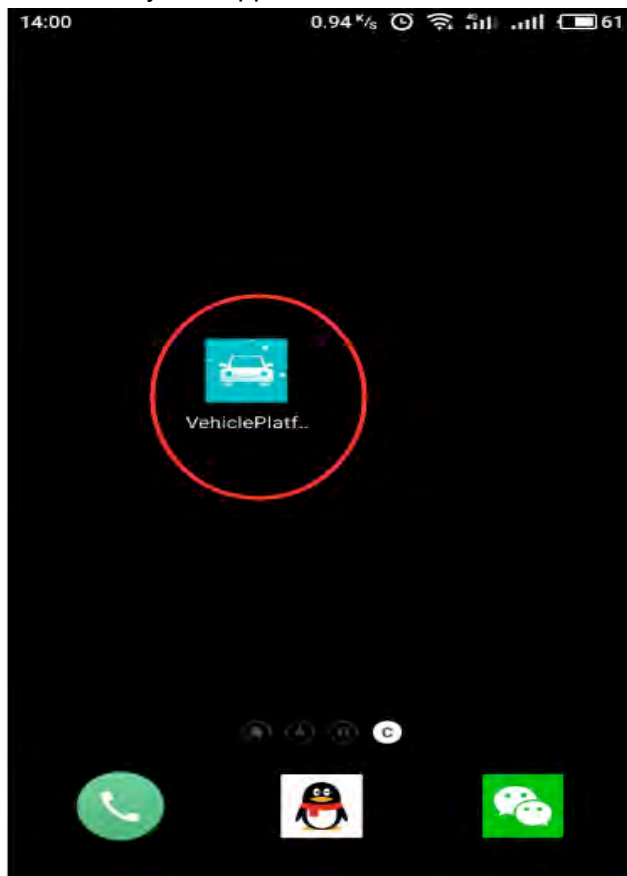

- 2: Open configuration software, click device searching;



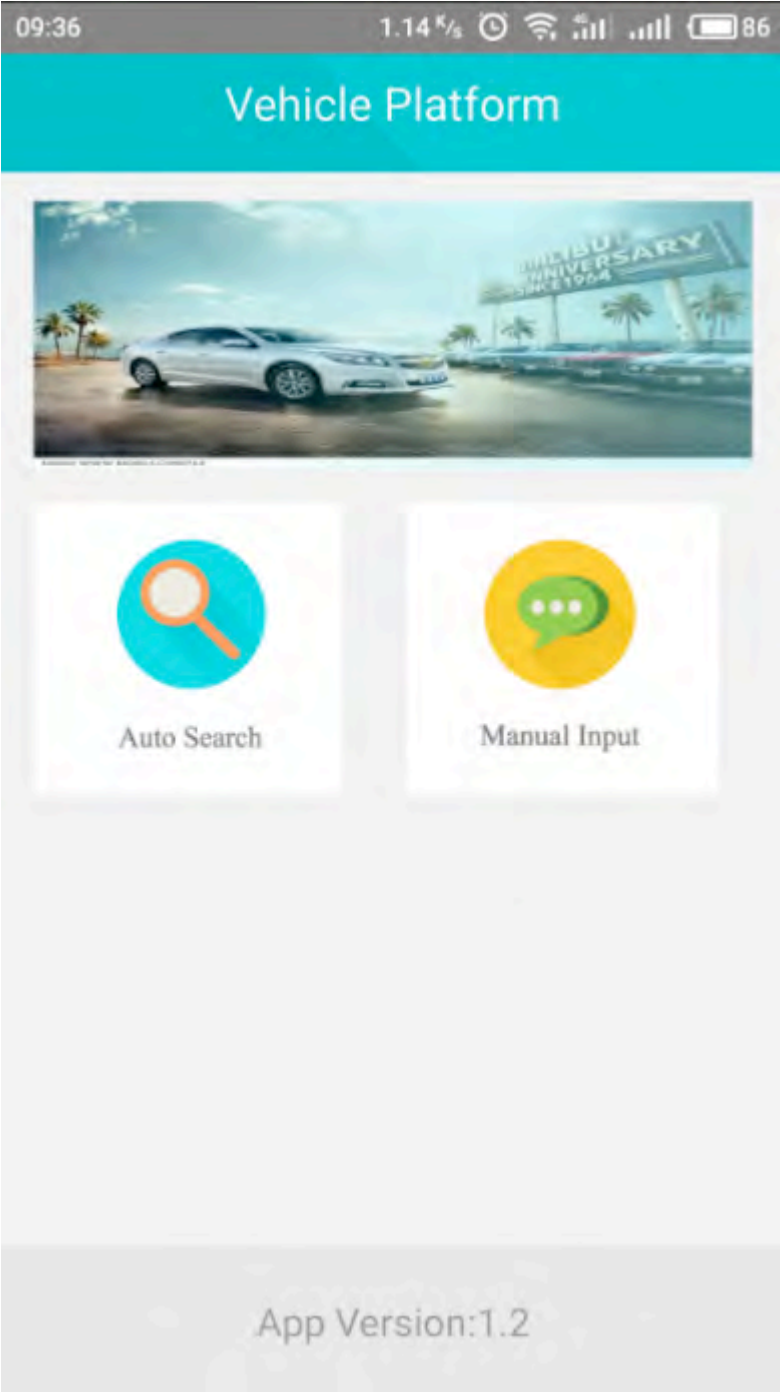

3: Device found as below:



4: Click the device found and start to configure Dev No:

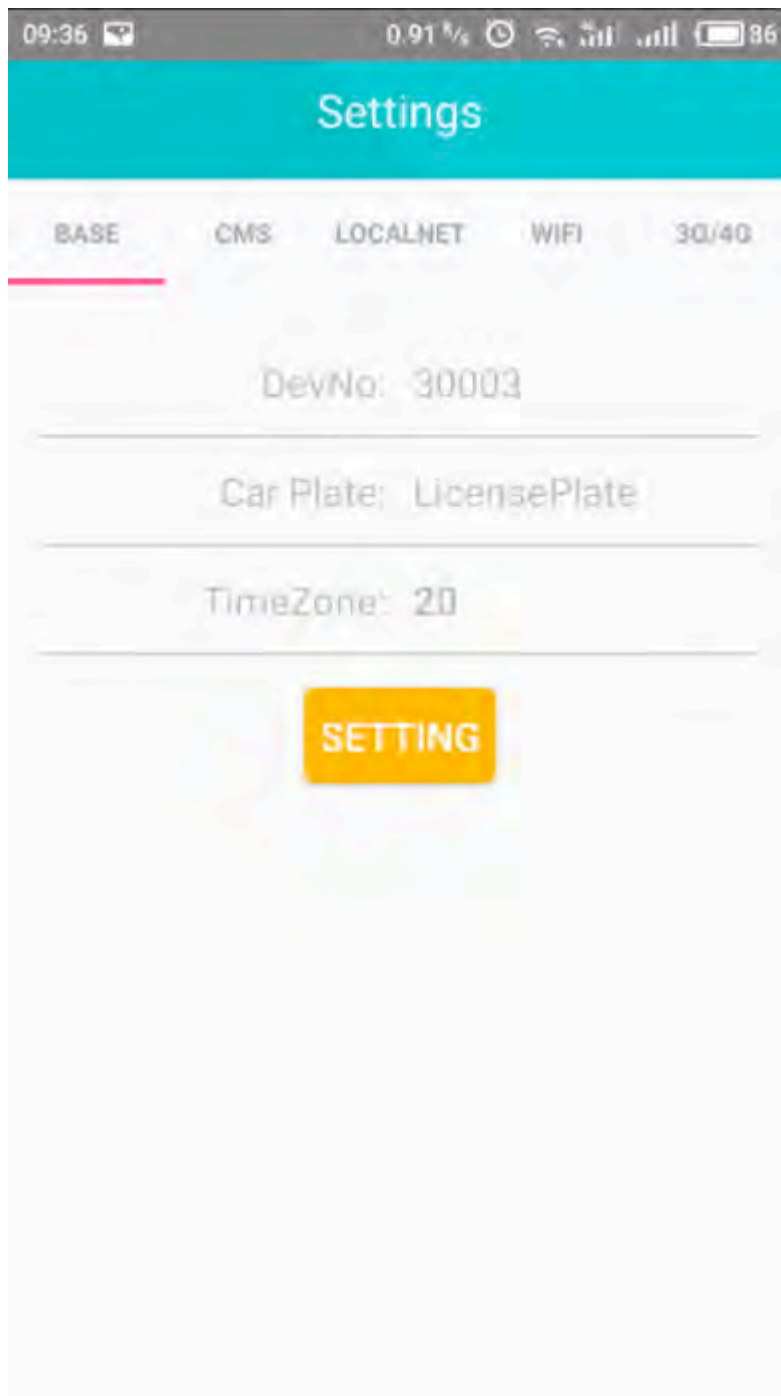

5: Configure server IP and server ports:

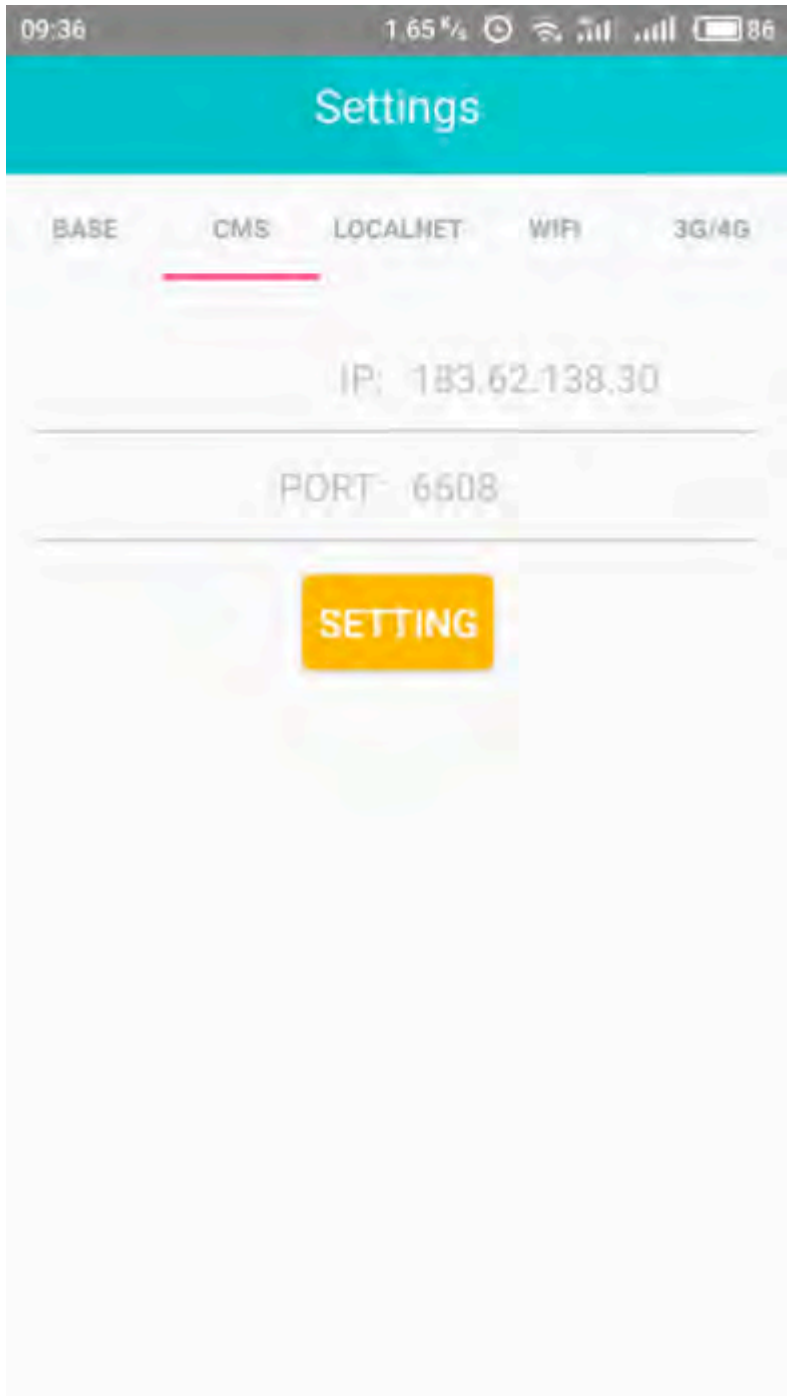

6: Locale IP configure, this page don't need to configure, could ignore:



- 7: Configure WIFI encryption model as: WPA2-PSK, encryption type as AES;
- SSID: WIFI account
- Password: WIFI password

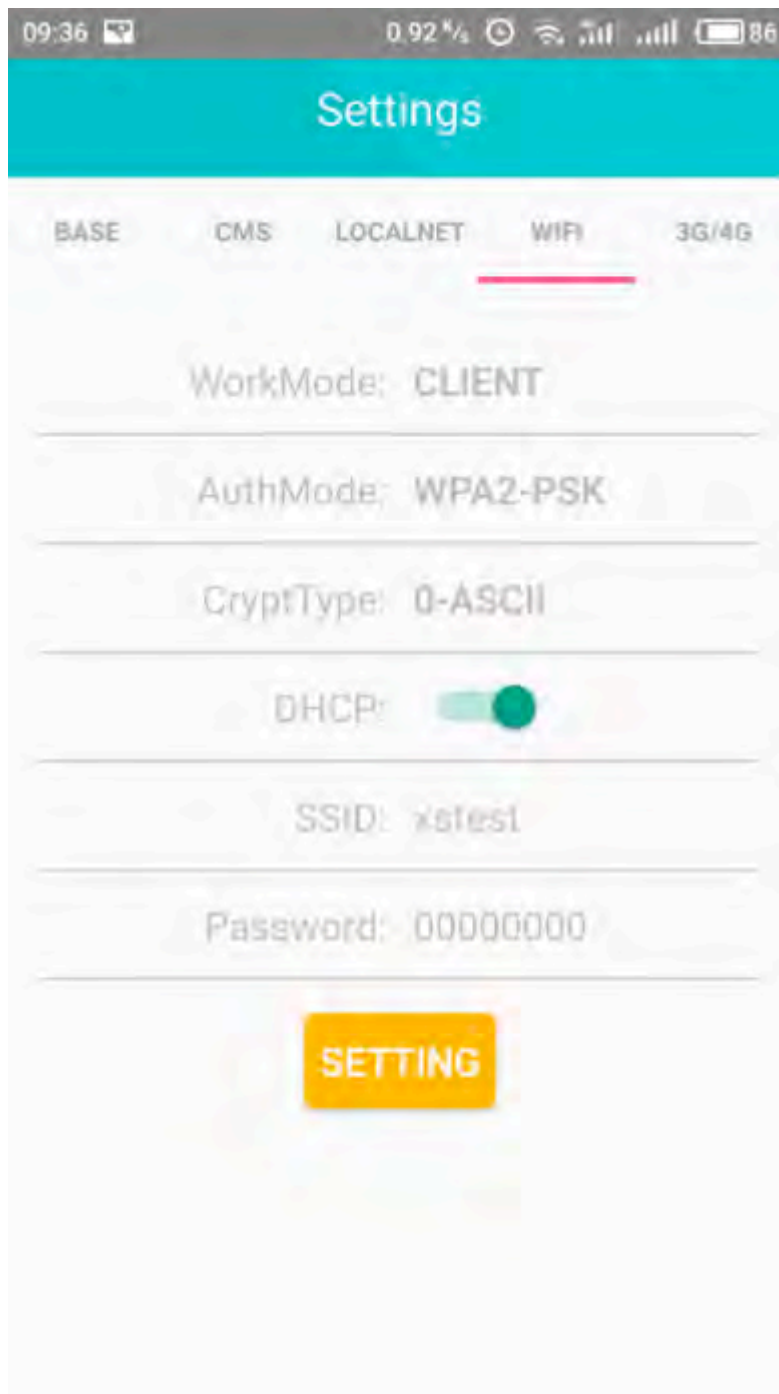

8: Select network 3G/4G configuration, not need to configure other parameters, configure NetType model as 3G/4G;

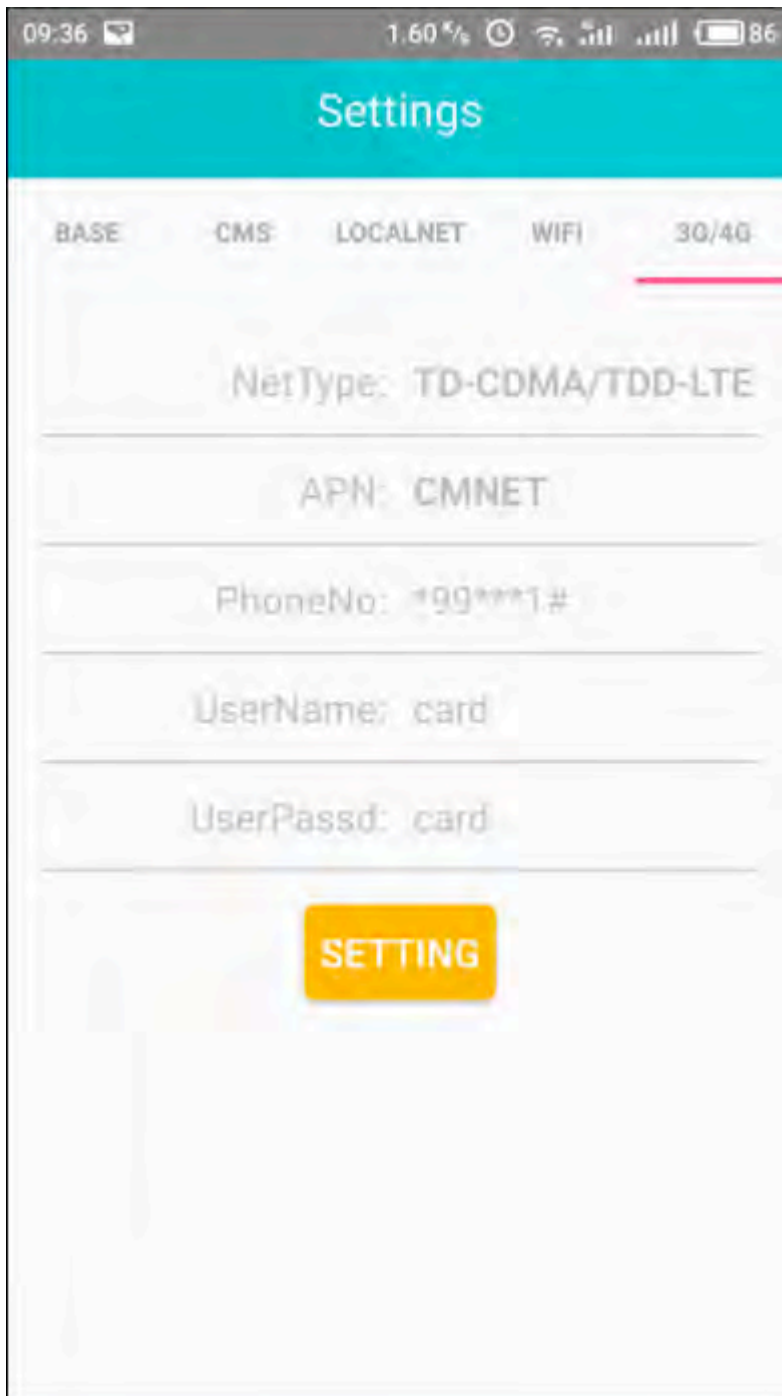

6.3: cmsv6 client configuration:

1: Log on cmsv6 client and find the device to configure (As image below):

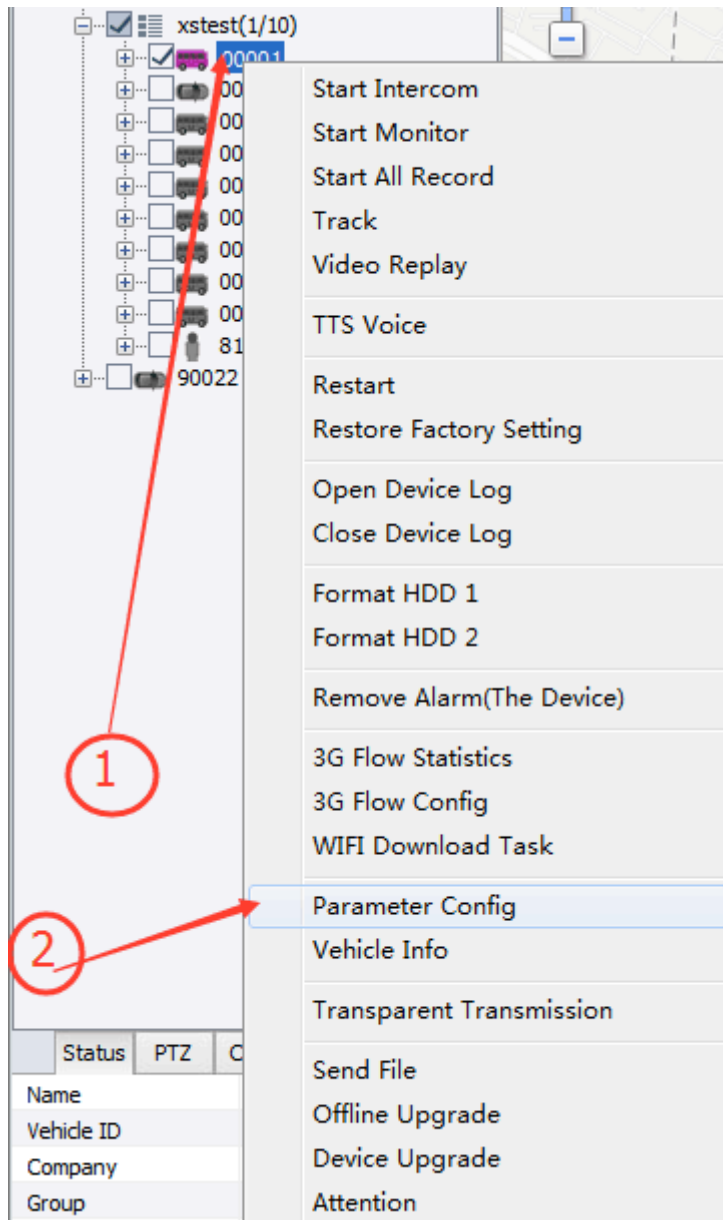

2: Locate to the menu on left side, click the item you want and modify related parameters (As image below):



